

rk steel smith
defining workspace



1500MM WIDE WORKBENCH
PRODUCT RANGE

2018



Workbench
1500 Wide

03 to 08



Workbench
1500 Wide Plain drawers (No Partition and Divider) 09 & 10



Workbench
Wooden Top & Vice 11 & 13



Workbench
Wooden Top & Vice 14



Workbench
Drawer Layout 15



Workbench
Over head Perfo. Panel



16 to 18

Technical Detail -

(1) Overall Dimension: **1500mm W. X 750mm D. X 850mm H.**

(4) Work Top Accessories Option: **Page-14**

(7) Standard: **Plain Drawer** (Option: **Drawers interior- Page-15**)

(2) Drawer Normal Extension: **80%**

(5) Usable drawer dimensions : **450mm W. x 450mm D.**

(8) Overhead Perfo. Panel Option: **Page-16 to 18**

(3) Each drawer load cap.: **60kg. UDL**

(6) Static Load Cap. **500kg.**



with back or bottom leg support

RK WS 1500 001



with back or bottom leg support

RK WS 1500 002



with back or bottom leg support

Available drawer configuration model:

RK WS 1500 009 ▶ 100X3 Drawer

RK WS 1500 010 ▶ 150X2 Drawer



with back or bottom leg support

Available drawer configuration model:

RK WS 1500 005 ▶ 100X3 Drawer

RK WS 1500 006 ▶ 150X2 Drawer



150

550H. Shelf

Retractable shelf

RK WS 1500 007 100X3 Drawer



100

150

400H.

Door with Retractable shelf

RK WS 1500 008



100

100

100

400H.

Door with Retractable shelf

RK WS 1500 011

Technical Detail -

- (1) Overall Dimension: **1500mm W. X 750mm D. X 850mm H.**
- (2) Drawer Normal Extension: **80%**
- (3) Each drawer load cap.: **60kg. UDL**
- (4) Work Top Accessories Option: **Page-14**
- (5) Usable drawer dimensions : **450mm W. x 450mm D.**
- (6) Static Load Cap. **500kg.**
- (7) Standard: **Plain Drawer** (Option: Drawers interior- **Page-15**)
- (8) Overhead Perfo. Panel Option: **Page-16 to 18**



Available drawer configuration model:

- RK WS 1500 012** ▶ 100X2, 200X1, 300X1 Drawers
- RK WS 1500 013** ▶ 75X2, 100X2, 150X1, 200X1 Drawers
- RK WS 1500 014** ▶ 100x1, 150X2, 300X1 Drawers
- RK WS 1500 015** ▶ 100x2, 150X2, 200X1 Drawers
- RK WS 1500 016** ▶ 100x4, 150X2 Drawers



RK WS 1500 022



Available drawer configuration model:

- RK WS 1500 017** ▶ 100X2, 200X1, 300X1 Drawers (L&R)
- RK WS 1500 018** ▶ 75X2, 100X2, 150X1, 200X1 Drawers (L&R)
- RK WS 1500 019** ▶ 100x1, 150X2, 300X1 Drawers (L&R)
- RK WS 1500 020** ▶ 100x2, 150X2, 200X1 Drawers (L&R)
- RK WS 1500 021** ▶ 100x4, 150X2 Drawers (L&R)



RK WS 1500 023



RK WS 1500 024

Technical Detail -

- (1) Overall Dimension: **1500mm W. X 750mm D. X 850mm H.**
- (4) Work Top Accessories Option: **Page-14**
- (7) Standard: **Plain Drawer** (Option: Drawers interior- **Page-15**)

- (2) Drawer Normal Extension: **80%**
- (5) Usable drawer dimensions : **450mm W. x 450mm D.**
- (8) Overhead Perfo. Panel Option: **Page-16 to 18**

- (3) Each drawer load cap.: **60kg. UDL**
- (6) Static Load Cap. **500kg.**



Available drawer configuration model:

- RK WS 1500 027** ▶ 100X3 Drawer
- RK WS 1500 028** ▶ 150X2 Drawer



Available drawer configuration model:

- RK WS 1500 029** ▶ 100X2, 200X1, 300X1 Drawers
- RK WS 1500 030** ▶ 75X2, 100X2, 150X1, 200X1 Drawers
- RK WS 1500 031** ▶ 100x1, 150X2, 300X1 Drawers
- RK WS 1500 032** ▶ 100x2, 150X2, 200X1 Drawers
- RK WS 1500 033** ▶ 100x4, 150X2 Drawers

Technical Detail -

(1) Overall Dimension: **1500mm W. X 750mm D. X 850mm H.**

(4) Work Top Accessories Option: **Page-14**

(7) Standard: **Plain Drawer** (Option: **Drawers interior- Page-15**)

(2) Drawer Normal Extension: **80%**

(5) Usable drawer dimensions : **450mm W. x 450mm D.**

(8) Overhead Perfo. Panel Option: **Page-16 to 18**

(3) Each drawer load cap.: **60kg. UDL**

(6) Static Load Cap. **500kg.**



RK WS 1500 034



RK WS 1500 035



RK WS 1500 036



RK WS 1500 037



RK WS 1500 038



RK WS 1500 039



RK WS 1500 040



RK WS 1500 041

1500 Wide Workstation

40mm X 40mm X 2mm thk. Square Pipe Frame

Technical Detail -

(1) Overall Dimension: **1500mm W. X 750mm D. X 850mm H.**

(4) Work Top Accessories Option: **Page-14**

(7) Standard: **Plain Drawer** (Option: Drawers interior- **Page-15**)

(2) Drawer Normal Extension: **80%**

(5) Usable drawer dimensions : **450mm W. x 450mm D.**

(8) Overhead Perfo. Panel Option: **Page-16 to 18**

(3) Each drawer load cap.: **60kg. UDL**

(6) Static Load Cap. **800kg.**



RK WS 1500 042



RK WS 1500 043



RK WS 1500 044



RK WS 1500 045



RK WS 1500 046



RK WS 1500 047



RK WS 1500 048



RK WS 1500 049



RK WS 1500 050



RK WS 1500 051



RK WS 1500 052



RK WS 1500 053

1500 Wide Workstation

40mm X 40mm X 2mm thk. Square Pipe Frame

Technical Detail -

(1) Overall Dimension: **1500mm W. X 750mm D. X 850mm H.**

(4) Work Top Accessories Option: **Page-14**

(7) Standard: **Plain Drawer** (Option: **Drawers interior- Page-15**)

(2) Drawer Normal Extension: **80%**

(5) Usable drawer dimensions : **450mm W. x 450mm D.**

(8) Overhead Perfo. Panel Option: **Page-16 to 18**

(3) Each drawer load cap.: **60kg. UDL**

(6) Static Load Cap. **800kg.**



Technical Detail -

- (1) Overall Dimension: **1500mm W. X 750mm D. X 850mm H.**
- (4) Work Top Accessories Option: **Page-14 (066 to 075 model)**
- (7) Standard: **Plain Drawer**

- (2) Drawer Normal Extension: **80%**
- (5) Usable drawer dimensions : **450mm W. x 450mm D.**
- (8) Overhead Perfo. Panel Option: **Page-16 to 18**

- (3) Each drawer load cap.: **60kg. UDL**
- (6) Static Load Cap. **800kg.**



35mm Thk. Naked Ply top with 4 mm thk. Rubber sheet



RK WS 1500 066



RK WS 1500 067



RK WS 1500 068



RK WS 1500 069



RK WS 1500 070

3mm Thk. Metal Sheet top with edging (3 side up & front side down) .



RK WS 1500 071



RK WS 1500 072



RK WS 1500 073



RK WS 1500 074



RK WS 1500 075

Technical Detail -

- (1) Overall Dimension: **1500mm W. X 750mm D. X 850mm H.**
- (4) Work Top Accessories Option: **Page-14 (076 to 085 model)**
- (7) Standard: **Plain Drawer**

- (2) Drawer Normal Extension: **80%**
- (5) Usable drawer dimensions : **450mm W. x 450mm D.**
- (8) Overhead Perfo. Panel Option: **Page-16 to 18**

- (3) Each drawer load cap.: **60kg. UDL**
- (6) Static Load Cap. **800kg.**



35mm Thk. Naked Ply top with 4 mm thk. Rubber sheet



RK WS 1500 076



RK WS 1500 077



RK WS 1500 078



RK WS 1500 079



RK WS 1500 080

3mm Thk. Metal Sheet top with edging (3 side up & front side down) .



RK WS 1500 081



RK WS 1500 082



RK WS 1500 083



RK WS 1500 084



RK WS 1500 085

Technical Detail -

- (1) Overall Dimension: **2080mm W. X 750mm D. X 850/1450mm H.**
- (4) Work Top Accessories Option: **Page-14**
- (7) Standard: **Plain Drawer** (Option: **Drawers interior- Page-15**)

- (2) Drawer Normal Extension: **80%**
- (5) Usable drawer dimensions : **450mm W. x 450mm D.**
- (8) Overhead Perfo. Panel Option: **Page-16 to 18**

- (3) Each drawer load cap.: **60kg. UDL**
- (6) Static Load Cap. **500kg.**

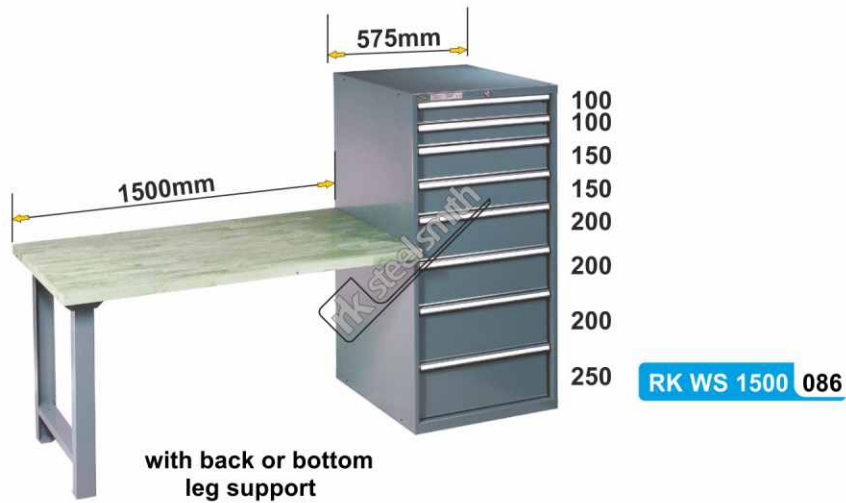

Technical Detail -

- (1) Overall Dimension: **3560mm W. X 750mm D. X 850/1450mm H.**
- (4) Work Top Accessories Option: **Page-14**
- (7) Standard: **Plain Drawer** (Option: **Drawers interior- Page-15**)

- (2) Drawer Normal Extension: **80%**
- (5) Usable drawer dimensions : **450mm W. x 450mm D.**
- (8) Overhead Perfo. Panel Option: **Page-16 to 18**

- (3) Each drawer load cap.: **60kg. UDL**
- (6) Static Load Cap. **500kg.**

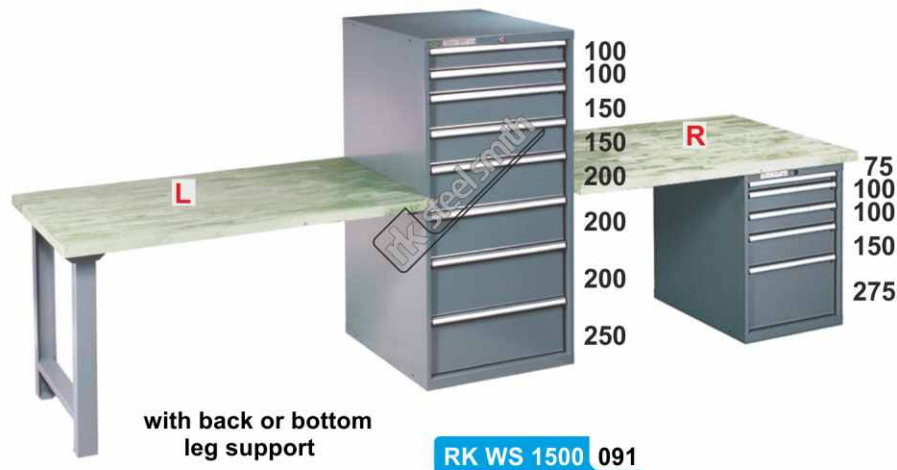

Technical Detail -

- (1) Overall Dimension: **3560mm W. X 750mm D. X 850/1450mm H.**
- (4) Work Top Accessories Option: **Page-14**
- (7) Standard: **Plain Drawer** (Option: **Drawers interior- Page-15**)

- (2) Drawer Normal Extension: **80%**
- (5) Usable drawer dimensions : **450mm W. x 450mm D.**
- (8) Overhead Perfo. Panel Option: **Page-16 to 18**

- (3) Each drawer load cap.: **60kg. UDL**
- (6) Static Load Cap. **500kg.**



RK WS TOP 001



Rubber sheet

35mm Thk. (Standard)
50mm Thk. (Option) Ply top
and 4mm Thk. Loose rubber sheet
Border cover with solid wood
with natural polish.

RK WS TOP 002



Angle section edging (4 side)

35mm Thk. (Standard)
50mm Thk. (Option) Ply top and
4mm Thk. Rubber sheet with
Angle section edging (4 side)
covered with a 1.5 mm thk.

RK WS TOP 003

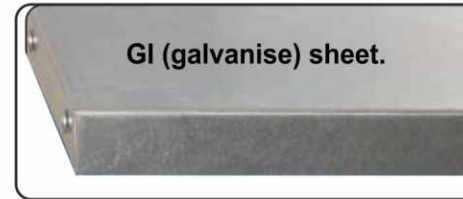

GI (galvanise) sheet.

35mm Thk. (Standard)
50mm Thk. (Option) Ply top
covered with a 1.5 or 2.0 mm thk.
GI (galvanise) sheet.

RK WS TOP 004

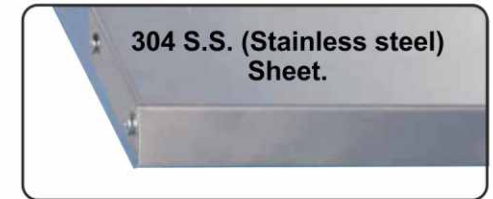

304 S.S. (Stainless steel) Sheet.

35mm Thk. (Standard)
50mm Thk. (Option) Ply top
covered with a 1.5 or 2.0 mm thk.
304 S.S. (Stainless steel) Sheet.

RK WS TOP 005

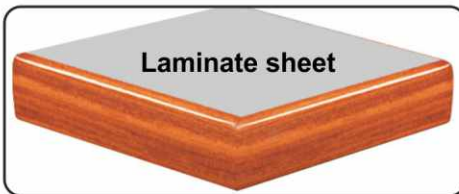

Laminate sheet

35mm Thk. (Standard)
50mm Thk. (Option) Ply top
1mm Laminate Sheet,
Border cover with solid wood
with natural polish.

RK WS TOP 006

MS Plate use only Page no - 7 & 8 Workbench

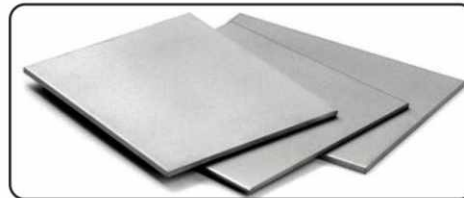

6mm Thk. (Standard) MS Plate
8mm Thk. (Option) MS Plate
10mm Thk. (Option) MS Plate

Extra heavy duty work - Teak wood log



- RK WS TOP 007** 50mm Thk.
- RK WS TOP 008** 75mm Thk.
- RK WS TOP 009** 100mm Thk.

50 X 50 / **75** / **100** mm Thk. (Standard) Teak wood log

All log jointing with adhesive & 16mm round bar

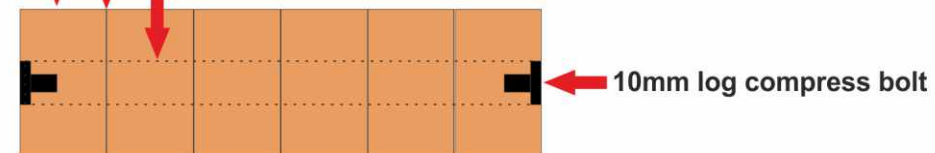

- RK WS VS 001** Front way jaw open (100 mm Jaw Vice)
- RK WS VS 002** Front way jaw open (125 mm Jaw Vice)
- RK WS VS 003** Front way jaw open (150 mm Jaw Vice)



Drawers Layout for 75 to 150mm H. Drawers (150mm onward plain drawers)

RK WS DR 600-1

450W X 450D
75mm to 300mm
drawers



RK WS DR 600-2

450W X 450D
75mm to 300mm
drawers



RK WS DR 600-3

Each 150W X 450D-4no.
compartment
75/100/150 drawers

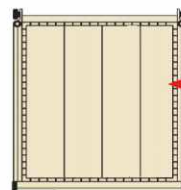

Long tool
storage

RK WS DR 600-4

Each 225W X 150D-6no.
compartment
75/100/150 drawers

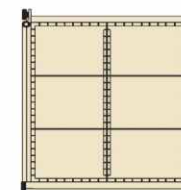

RK WS DR 600-5

Each 150W X 150D-9no.
compartment
75/100/150 drawers

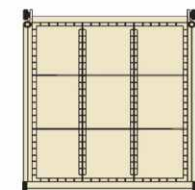

Plastic container only for 75 & 100mm H. Drawers



45mm H.
75mm Drawers



75mm H.
100mm Drawers

RK WS DR 600-P1

75/100 drawers

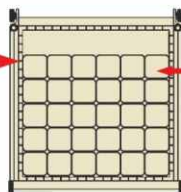

75W.X75D.X45/75H.
30no.
Plastic container
in each drawer

RK WS DR 600-P2

75/100 drawers

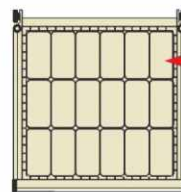

75W.X150D.X45/75H.
18no.
Plastic container
in each drawer

RK WS DR 600-P3

75/100 drawers

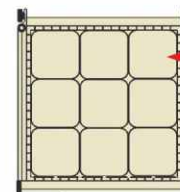

150W.X150D.X45/75H.
09no.
Plastic container
in each drawer

RK WS DR 600-P4

75/100 drawers

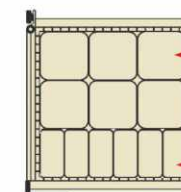

150W.X150D.X45/75H.
06no.
Plastic container
in each drawer
75W.X150D.X45/75H.
06no.
Plastic container
in each drawer

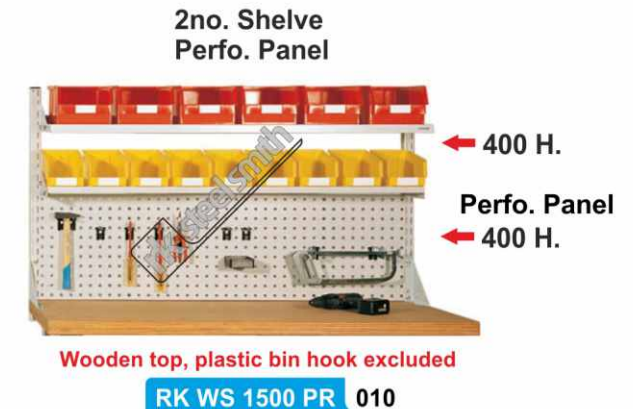
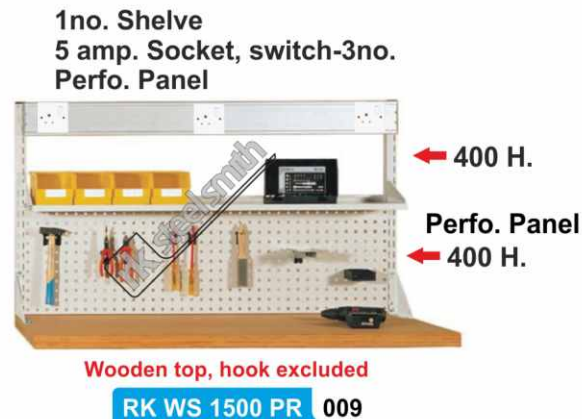
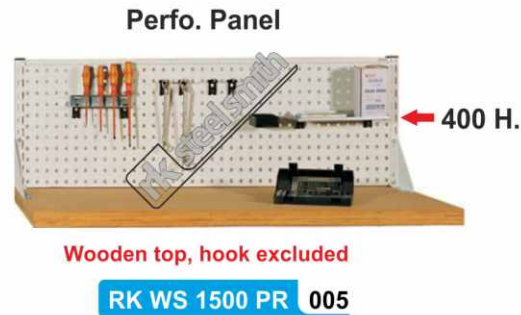

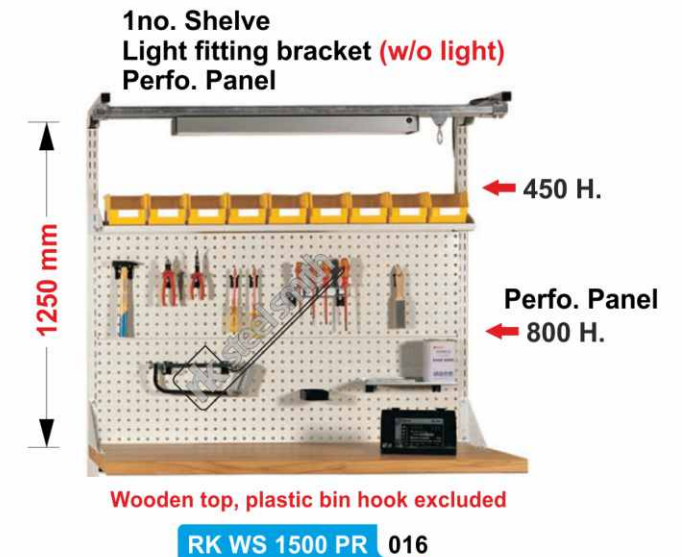
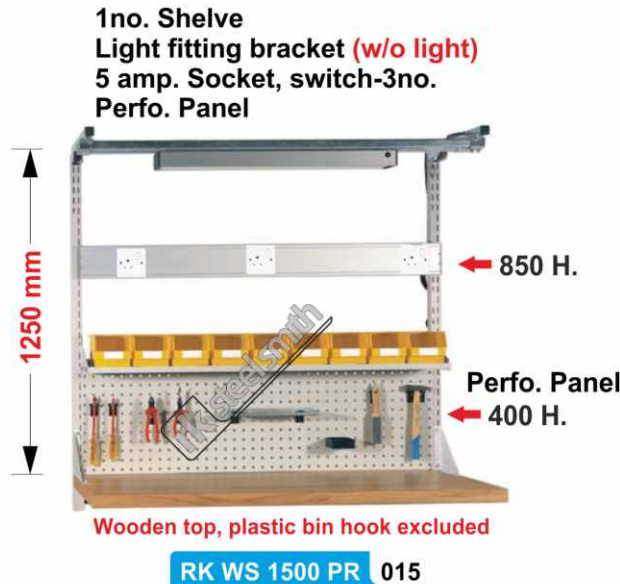
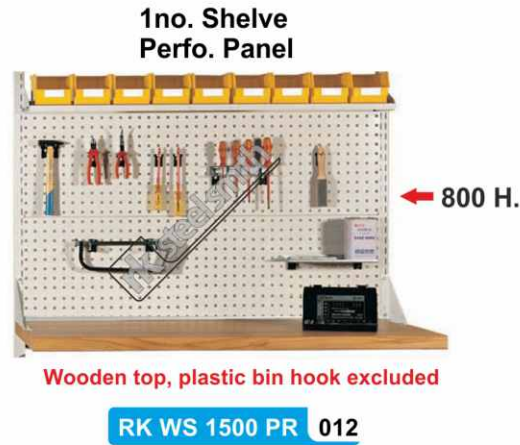
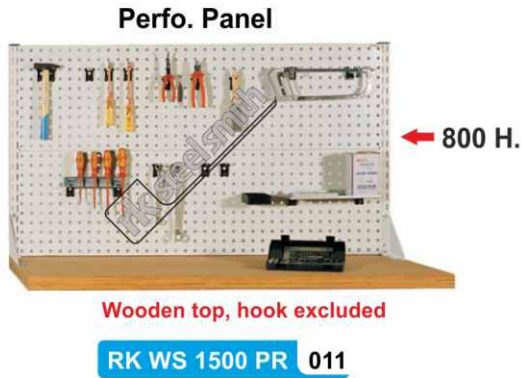

2no. Shelf
Light fitting bracket (w/o light)
5 amp. Socket, switch-3no.



Plastic bin & hook excluded

RK WS 1500 PR 017

4no. Shelf
Light fitting bracket (w/o light)
5 amp. Socket, switch-3no.



Plastic bin & hook excluded

RK WS 1500 PR 018

2no. Shelf
Light fitting bracket (w/o light)
Perfo. Panel
5 amp. Socket, switch-3no.



Plastic bin & hook excluded

RK WS 1500 PR 019

1no. Shelf
Light fitting bracket (w/o light)
Perfo. Panel
Plain Panel
5 amp. Socket, switch-3no.



Plastic bin & hook excluded

RK WS 1500 PR 020

3no. Shelf
Light fitting bracket (w/o light)
Perfo. Panel
5 amp. Socket, switch-3no.



Plastic bin & hook excluded

RK WS 1500 PR 021

Standard Color option :



AMERICAN BLUE
STRUCTURE FINISH



7035 PALE GREY
STRUCTURE FINISH



DA GREY
STRUCTURE FINISH



PO RED
STRUCTURE FINISH

Assembled components are transfer to pre-treatment plant for treating in 7 tank for degrees, zinc, phosphating and passivation.

Material received from pre-treatment department are immediately powder coated in the dust free painting booth and then the articles are put inside a baking oven at a temperature of 180° C for about 20 minutes.



rk steel smith
defining workspace



Plot- B/32 (Part-2) Bileshwar Indl. Estate,
Opp. G.V.M.M.,
Odhav-Kathwada Road,
Ahmedabad - 382415
Gujarat (INDIA).



+91 94 281 35 100
+91 98 253 00 059



rksteelsmith@gmail.com
info@rksteelsmith.com
sales@rksteelsmith.com



www.rksteelsmith.com